



Greenhouse production baskets | Urban products | Garden center equipment



MULTI-FORMES
Horticulture



Coco Terro
Products
4 - 11



Urban Products
34 - 39



Production baskets
and accessories
12 - 21



Garden-center products
40 - 50
Floral arrangements
51



The Multi-Formes
Collection
22 - 33



Nurseries products
52 - 57



Custom made
Products
58 - 59





100%

NATURE



Coco mulch, see page 8 and following for more details



BioDiscs, see page 9 and following for more details



Coco rolls, see page 10 and following for more details

SUBSTRATO SUSTENTÁVEL PARA CULTIVAR SUS CULTIVARES



GOOD GARDENER & COCO TERRO POTTING SOIL MIX

Our brand new Coco Terro Potting Soil mix collection has finally arrived!

This compact potting soil mix, fertilized and ready-to-use soil is made from 100% natural coconuts. Light and compact, this potting soil mix will quickly replace bulky pockets of soil in your garden!

The new collection comes in two categories, the **Good Gardener** range for small, compact 1L size for urban or home gardening, indoor or outdoor. The other category, superior **Coco Terro Potting Soil Mix**, is built in larger formats for larger needs and is available in 5L, 10L and 20L formats.

The two new ranges are ready for use and very easy to handle:

- Add a little water and the soil will swell by itself
- This product is already naturally fertilized and ready to use
- Retains moisture better than conventional potting soil



	1 L	5 L	10 L	20 L
#	675-01L	675-05L	675-10L	675-20L
ADD WATER	350 ml	1.75 L	3.5 L	7 L
THICKNESS	1 cm	2 cm	3.5 cm	7 cm
LENGTH	10 x 10 cm	18 x 18 cm	18 x 18 cm	18 x 18 cm
CASES/PALLET	230	4000	2000	1000



COCO GROW STAKES

Indoor plants in pots or containers need help to climb tall.

These coconut grow sticks are ideal for your climbing ivy, monstera plants, etc. The 100% natural coconut fiber membrane surrounding the stem allows plants to grab onto this organic material and grow properly vertically.



	45 cm	60 cm	90 cm
#	685-45CM	685-60CM	685-90CM
DIAMETER	4.5 cm	4.5 cm	4.5 cm
UNITS/CASE	12	12	12



Input approved for organic agriculture by Ecocert Canada



COCO MULCH

In addition to preventing weeds growth, Coco Terro mulch gives a single and distinctive appearance to flower beds.

- 100 % natural coco nutshell fragments
- Retains moisture, requires less watering
- Adds organic nutrients to your soil
- Compacted and dry material, does not leak like colored mulches
- Contains no color, chemical or other toxic additives
- Neutral pH (5.5 — 6.5)
- Last for 3 years +



Input approved for organic agriculture by Ecocert Canada



COCO PEAT

Ideal for nurseries, tree plantation and urban areas gardening, our Coco Terro peat is a very good substitute for peat moss / better for the environment – renewable resource.

- 100% natural!
- Suitable for all types of plants
- No need for adding chemicals or toxic materials
- Neutral pH (5.5 – 6.5)
- Improves soil drainage and aeration
- Biodegradable, adds organic nutrients to soil
- Last 2 to 3 years

EASY AND
ECO-FRIENDLY



One 4 kg (8.5 lb) **block of Coco mulch** yields 2.5 cubic feet of mulch when water is added which is equivalent to a 56 litres bag of cedar mulch weighting 30 lb and this without taking into account a 15% + compaction rate for cedar.

One 5kg (11 lb) **block of Coco peat** yields 3.3 cubic feet of coco peat after water is added.

	980-MULCH	975-PEAT
BLOCK SIZE	12"X12"X4.5"	11"X11"X4.5"
WEIGHT	4kg	5kg
BLOCKS PER PALLET	216	272



BioDISCS

Best suited for nurseries, tree plantations and even for small cultures in urban areas.

- 100% Natural compressed coconut fibers with latex coating on one side that needs to be face down (latex is a natural adhesive produced by Heveas–rubber trees)
- Biodegradable, enriches the soil with organic materials
- Preserve soil moisture
- Water and fertilizer will go through and mix with soil
- Eliminate the use of toxic products (weed-killer)
- Neutral pH (5.5-6.5)
- Last from 2 to 3 years
- Input approved for organic agriculture by ECOCERT Canada

CONSULT OUR ENVIRONMENTAL CATALOG AT WWW.MULTI-FORMES.COM

FOR NURSERY*

	16 cm	21 cm	24 cm	27 cm	29 cm	34 cm
#	650-16cm	650-21cm	650-24cm	650-27cm	650-29cm	650-34cm
THICKNESS	8-10 mm	8-10 mm	8-10 mm	8-10 mm	8-10 mm	8-10 mm
POT SIZE	1 g	2 g	2.5 g	3 g	4 g	5 g
WEIGHT gr/m ²	1000-1200	1000-1200	1000-1200	1000-1200	1000-1200	1000-1200
UNITS/CASE	740	470	370	270	240	50

*Other sizes available upon request.

PLANTATION VEGETABLE PRODUCTION

RETAIL

METAL U-STAKES

	45 cm		60 cm			34 cm			45 cm			60 cm			Used to install BioDISCS and Coco ROLLS.		
	620-45cm	620-60cm	651-34cm	651-45cm	651-60cm	8-10 mm	10-14 mm	10-14 mm	6"	8"	6" Biodegradable	#	CALIBER	CASE			
THICKNESS	10-14 mm	10-14 mm	8-10 mm	10-14 mm	10-14 mm	8-10 mm	10-14 mm	10-14 mm	430-AN6*	430-AN8*	430-ANBIO6						
WEIGHT gr/m ²	1200-1300	1200-1300	1000-1200	1200-1300	1200-1300	1000-1200	1200-1300	1200-1300	11g	11g	-						
UNITS/CASE	50	50	5	3	1	5	3	1	1000	500	1000						

*Also available in case of 50 units

COCO ROLLS

NOW IN 3 SIZES!

Made of 100% natural coconut fibers. Ideal for organic vegetable gardening, hedge planting and organic farming.

- Prevents weed growth in gardens and flower beds
- Made from 100% natural coco fibers
- Input approved for organic agriculture by Ecocert Canada
- Biodegrades in 2 years
- Retains soil moisture
- Adds organic nutrients to the soil during biodegradation



Input approved for organic agriculture by Ecocert Canada



	50 cm	100 cm	0.92 m
#	401- Mini Roll	401-Med Roll	401-Roll
THICKNESS	6.5 mm	6.5 mm	6.5 mm
LENGTH	150 cm	150 cm	7.6 m
CASES/PALLET	625	310	28

Input approved for organic agriculture by Ecocert Canada



1 gallon

646 cc

412 cc

COCO FIBER POTS

Start your plant with these coco fiber pots. 100% natural, including the natural latex adhesive. They will greatly strengthen the plant root system, will biodegrade in 3 months when put in the ground and at the same time will enrich the soil with nutrients.

Pots will last for 2 years in Greenhouses conditions. (not buried into the soil)

	9.5 cm	11 cm	16 cm	23 cm
#	991-9	992-11	900-POT1	900-POT2
HEIGHT	8.5 cm	10 cm	16.5 cm	20 cm
SOIL CAPACITY	412 cc	646 cc	1 gallon	2 gallons
CASE	1200	950	50	25

Other sizes available upon request.

A LARGE
VARIETY OF
DECORATIVE
BASKETS AND
ACCESSORIES

PRODUCTION BASKETS

Unleash your imagination and impress your clientele with magnificent flower baskets.

Beautiful and original floral arrangements will make you stand-out from competitors.

OUR FAVORITE!

HALF-BASKET
with COCO LINER
405-D16CO
Case: 6
Width: 16"
Height: 9"
11L soil capacity



Metal-wire basket painted with a top quality black finish. Comes with COCO TERRO top quality coco liner with plastic insert to protect the root system from drought



Decorative basket, see page 22 and following for more details



Simple flower box, see page 16 for more details

PRODUCTION BASKETS FOR VICTORIAN

Planting through the sides of our custom-fitted plastic bag (included) will produce large and luxuriant flower baskets. Within 15 days, the flowers will completely cover the plastic bag.

This sturdy basket is made of galvanized steel wire that won't rust. It firmly holds bag, soil and plugs.

Its flat base facilitates the preparation of floral arrangements and makes transportation easy.

Draining: Drain your basket in piercing the bottom bag every 3rd wire rods.



	10"	12"	14"	16"	18"	22"	24"
#	400-J10	400-J12	400-J14	400-J16	400-J18	400-J22	400-J24
HEIGHT	6"	6.75"	7.25"	8"	9.75"	12"	13"
SOIL CAPACITY	6	9	13	18	34	44	56
CASE	12	12	12	12	12	12	12
CASES/PALLET	160	120	90	60	45	40	28
REPLACEMENT BAG	401-K (pqt 24)	401-A (pqt 24)	401-G (pqt 24)	401-B (pqt 24)	401-C (pqt 24)	401-J (pqt 24)	401-V (pqt 24)

* CUSTOM FITTED GREEN PLASTIC BAG INCLUDED WITH ALL MODELS

Floral arrangement?
QUICK AND EASY!
instructions on page 51

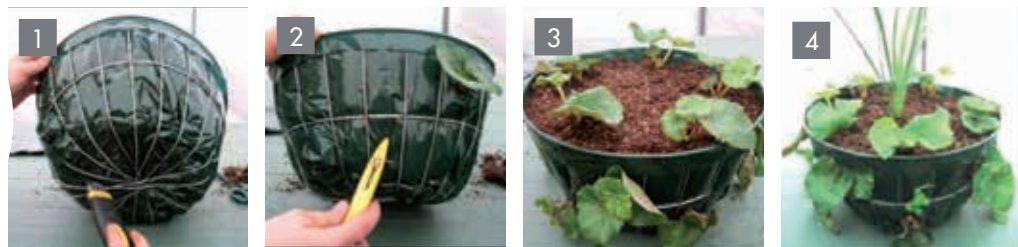

ARCH

Your plant will climb to it. Bloom your flower basket and display it on a table, terrace or by the swimming pool. You can use the handle to lift or move the basket.

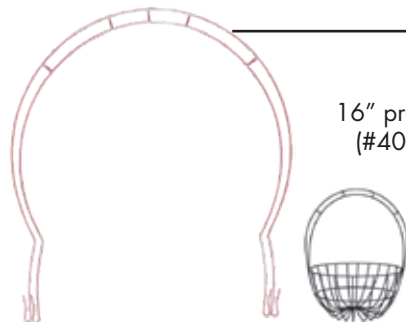

403-HD16

To be used with the 16" production basket only (#400-J16, not included).

Case: 12

* Do not hang.

Our baskets come with a metal frame and are fitted with a plastic bag.

Ideal for facades, balconies, porches, ramps... any space in need of adornment.

Create harmonious trios:

- baskets
- flower boxes
- half-baskets

Draining: Drain your basket, by piercing the bottom bag every 3rd wire rods.



16" half baskets :
Can also be used with
COCO TERRO liners
#401-L16D.
See page 19.

SIMPLE HALF-BASKET*



	12"	14"	16"
#	405-D12	405-D14	405-D16
HEIGHT	7.75"	9"	9"
SOIL CAPACITY	6	9	12
CASE	12	12	12
REPLACEMENT BAG	401-K	401-A	401-G

HALF BASKET WITH HEART-SHAPED ARCH*

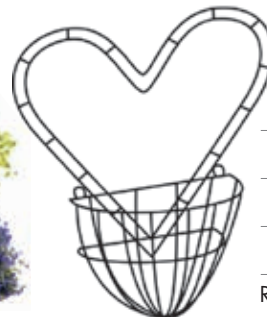

	16"
#	403-DC16
HEIGHT	9"
SOIL CAPACITY	12
CASE	6
REPLACEMENT BAG	401-G

HALF-BASKET WITH ARCH*



	14"
#	403-WR14
HEIGHT	9"
SOIL CAPACITY	9
CASE	6
REPLACEMENT BAG	401-A

* CUSTOM FITTED GREEN PLASTIC BAG INCLUDED WITH ALL MODELS

FLOWER BOXES

A facade is always more attractive with flower boxes.

They also dress up ramps and fences perfectly.



SIMPLE FLOWER BOX*

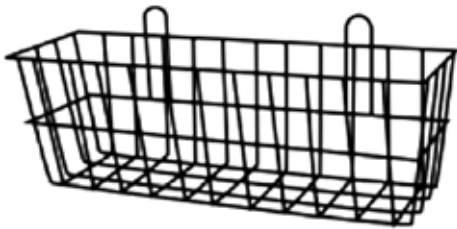

	12"	24"	30"	36"	36" Flower box bracing
#	404-B12	404-B24	404-B30	404-B36	404-ENT
HEIGHT	8"	8"	8"	8"	-
SOIL CAPACITY (L)	10	22	28	32	-
CASE	6	6	6	6	6
REPLACEMENT BAG	401-A	401-D	401-F	401-E	↔

FLOWER BOX WITH ARCH*



	24"
#	404-AR24
HEIGHT	8"
SOIL CAPACITY (L)	22
CASE	6
REPLACEMENT BAG	401-D

FLOWER BOX WITH HEART-SHAPED ARCH*



	24"
#	404-BL24
HEIGHT	8"
SOIL CAPACITY (L)	22
CASE	6
REPLACEMENT BAG	401-D

Find our flower box supports on page 45.

* CUSTOM FITTED GREEN PLASTIC BAG INCLUDED WITH ALL MODELS

STURDY HOOKS FOR HANGING BASKETS

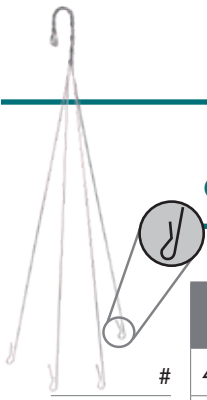

OPEN HOOK

	18"	18"	18"	22"	22"	22"	26"	26"
#	400-HK18	400-HK18-4	400-HK18PN	400-HK22	400-HK22-4	400-HK22PN	400-HK26	400-HK26PN
COLOR	Galvanized	Galvanized	Black	Galvanized	Galvanized	Black	Galvanized	Black
RODS	3	4	3	3	4	3	4	4
BASKET SIZE	10"-12"	10"-12"	10"-12"	14"-16"	14"-16"	14"-16"	18"	18"
OPENING	1.5"	1.5"	1.5"	1.5"	1.5"	1.5"	1"	1"
CASE	12	12	12	12	12	12	12	12



CLOSED HOOK

Recommended for urban production baskets. It is safer to replace the closed hooks every year.

	22"	26"	28"
#	400-LP22	400-LP26	400-LP28
COLOR	Galvanized	Galvanized	Galvanized
RODS	4	4	4
BASKET SIZE	10"-16"	18"-22"	24"
CASE	12	12	12

*Painted too.



CHAIN

	22"	22"	22"	25"	25"
#	400-CH22	400-CH22-4	400-CH22PN	400-CH25	400-CH25PN
COLOR	Galvanized	Galvanized	Black	Galvanized	Black
RODS	3	4	3	4	4
BASKET SIZE	10"-14"	10"-14"	10"-14"	16"-18"	16"-18"
OPENING	1"	1"	1"	1"	1"
CASE	12	12	12	12	12

EXTENSION HOOK

A durable, sturdy hook. Make the most of your available space by varying the height of your hanging baskets in the greenhouse. Made of galvanized steel. Calibre 9 (0.144 mm). Can support up to 25 lb.

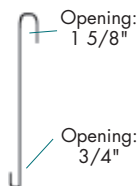

	8"	12"	18"	24"	30"	36"	48"
#	402-E08	402-E12	402-E18	402-E24	402-E30	402-E36	402-E48
CASE	100	50	50	50	50	50	50

HOOK FOR FLOWER BAG

Space optimizer. Practical for hanging two flower bags back to back. Your automatic watering system can be easily adapted. Calibre: 9 (0,144 mm)

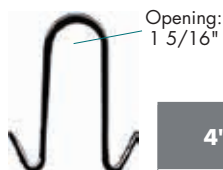

#	408-CPS
CASE	100

S-SHAPED HOOK

Sturdy hook (galvanized)
Gauge: 7 (0,176 mm)
Can support up to 50 lb.

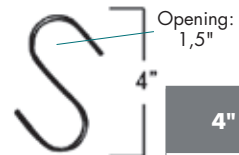

#	402-E03
CASE	100

COCO BASKETS

Protects roots from drought, COCO TERRO LINERS come with a plastic lining insert.

Metal-wire basket painted with a top-quality black finish.

Coco baskets offered in various shapes and sizes!
See page 19.



HALF-BASKET



BASKET



CONE



FLOWER BOX



Find our flower box supports on page 45.



Input approved for organic agriculture by Ecocert Canada



COCO TERRO LINERS REPLACEMENTS



For basket, half-basket and flower box.

BASKET SHAPES AND SIZES

Hooks and chains sold separately to better suit your needs.
See page 17.



	16"
#	405-D16CO
HEIGHT	9"
SOIL CAPACITY (L)	11
CASE	6



	12"	14"	16"	18"	22"
#	400-J12CO	400-J14CO	400-J16CO	400-J18CO	400-J22CO
HEIGHT	6.5"	7"	7.5"	9.5"	12"
SOIL CAPACITY (L)	8.5	12.5	17	31	44
CASE	12	12	12	12	12
PALLET	36 cs	45 cs	30 cs	15 cs	15 cs



	10"	12"	14"
#	400-C10CO	400-C12CO	400-C14CO
HEIGHT	13"	14"	15"
CASE	12	12	12



	24"	30"	36"
#	404-B24CO	404-B30CO	404-B36CO
HEIGHT	8"	8"	8"
SOIL CAPACITY (L)	20	25	30
CASE	6	6	6

Other sizes available upon request.



For BASKET	12"	14"	16"	18"	22"
#	401-L12	401-L14	401-L16	401-L18	401-L22
CASE	12	12	12	12	12

For HALF-BASKET	16"
#	401-L16D
CASE	12

For FLOWER BOX	24"	30"	36"
#	401-L24B	401-L30B	401-L36B
CASE	12	12	12

Input approved for organic agriculture by Ecocert Canada



NATURAL CEDAR BASKETS AND BARRELS



Basket
400-CED15



Barrel
400-BARR15



BASKET*

15"	
400-CED15	#
6.75"	HEIGHT
16	SOIL CAPACITY (L)
12	CASE
401-B	REPLACEMENT BAG

BARREL*

15"	21"	
400-BARR15	400-BARR21	#
12"	16"	HEIGHT
42	57	SOIL CAPACITY (L)
1	1	CASE

* PLASTIC BAG NOT INCLUDED.





MULTI-FORMES
DECORATIVES
BASKETS
PRODUCTIONS
RANCH

THE MULTI-FORMES COLLECTION

Multi-Formes has handpicked an assortment of ornamental baskets that are bound to please your customers.

THE ESSENTIALS

NATURAL MOSS BASKET
Available products, see page 25 for more details



CONE
750-45
Diameter: 14"
Height: 15"
Soil capacity: 9L
Case: 12



Refer to the related booking dates (see page 25) in order to receive your products on time.



BASKET CENTERPIECE
#749-70
Diameter: 8"
Base: 20"
Thickness: 7.5"
Case: 12



BASKET SHAPES AVAILABLE

SQUARE POINT

14"
750-07
750-10
750-71
750-76
750-78

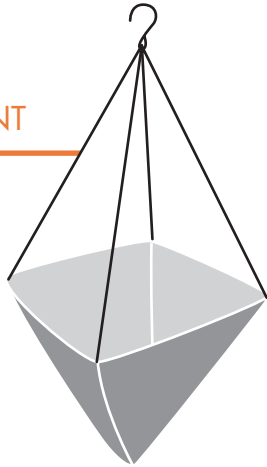

CONE

12"	14"	16"
750-01	750-02	750-50
	750-12	750-62
	750-18	750-70
	750-23	750-74
	750-36	750-79
	750-45	750-81
		750-03
		750-19
		750-24

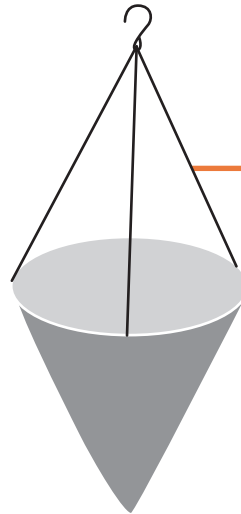

URN

750-13
750-27
750-40
750-77
750-80
750-83

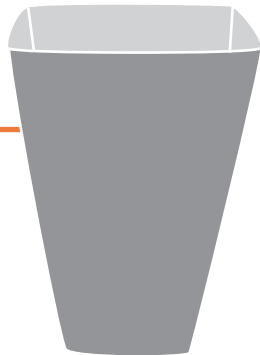

SQUARE

14"
750-11
750-26
750-33

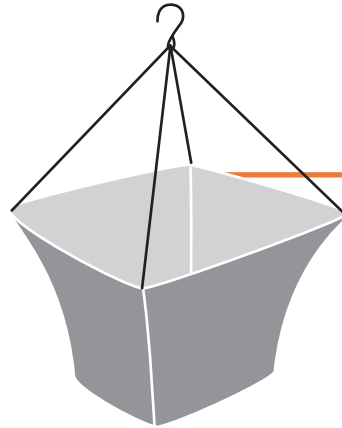

HALF-CONE

12"	14"
750-04	750-05
	750-20
	750-60
	750-84

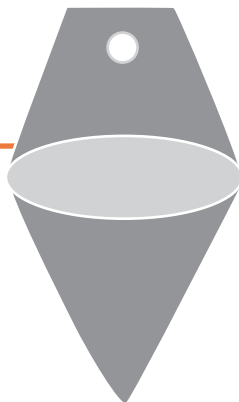

ROUND

12"	14"	16"
750-54	750-55	750-06
	750-72	750-30
	750-73	750-56
	750-82	

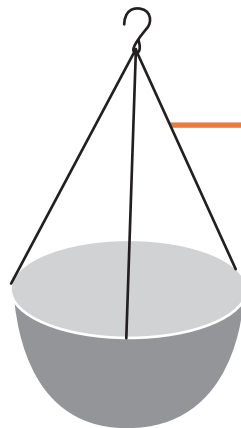

FLAT BASKET

14"
750-28
750-61
750-75



NATURAL MOSS BASKET

12"	14"	16"
400-J12 MOS	400-J14 MOS	400-J16 MOS

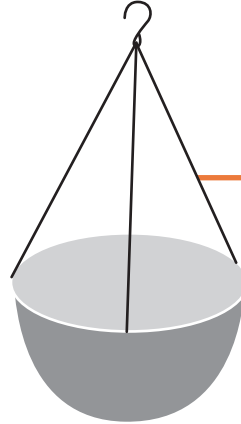

CONICAL EXTRA

14"
750-16

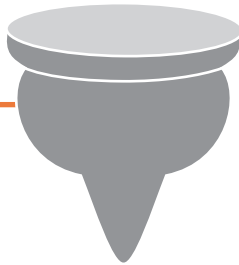

BEEHIVE

14"
750-15
750-31

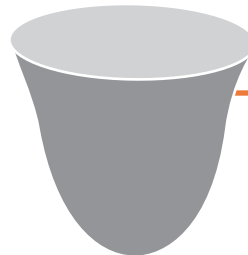

BASKET CENTERPIECE

20"
749-70
750-85



FLOWER BOX

30"
750-17
750-25
750-32
750-63



Find our
flower box
supports
on page 45.



PRE-SALE CALENDAR

1st BOOKING

Order by: **September 30th 2022**
Available in **February 2023 at the latest**

2nd BOOKING

Order by: **October 31st 2022**
Available in **March 2023 at the latest**

3rd BOOKING

Order by: **November 30th 2022**
Available in **April 2023 at the latest**

AVAILABLE PRODUCTS

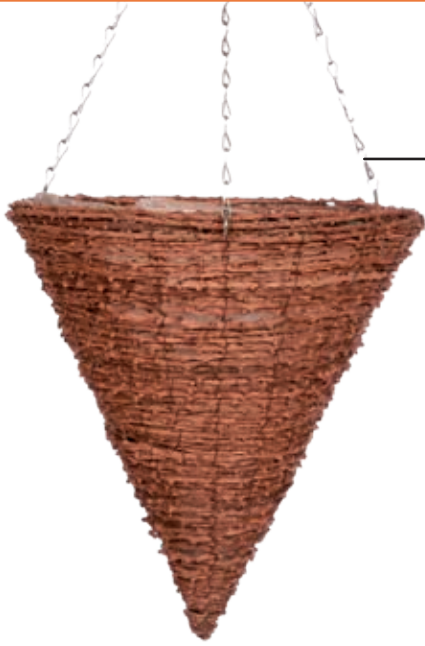

CONE 12"

#750-01
Diameter: 12"
Height: 14"
Soil capacity (L): 5
Case: 12

CONE 14"

#750-02
Diameter: 14"
Height: 15"
Soil capacity (L): 9
Case: 12

CONE 16"

#750-03
Diameter: 16"
Height: 17"
Soil capacity (L): 14
Case: 12



HALF-CONE 12"

#750-04
Diameter: 12"
Height: 23"
Soil capacity (L): 5
Case: 12

HALF-CONE 14"

#750-05
Diameter: 14"
Height: 23"
Soil capacity (L): 7
Case: 12



CONE 14"

750-45
Diameter: 14"
Height: 15"
Soil capacity (L): 9
Case: 12

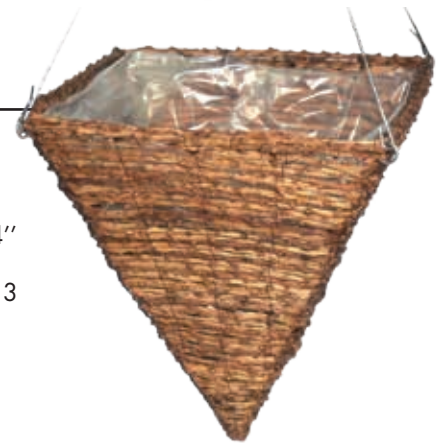

SQUARE POINT 14"

750-07
Diameter: 14"X14"
Height: 15"
Soil capacity (L): 13
Case: 12



ROUND 16"

750-06
Diameter: 16"
Height: 18"
Soil capacity (L): 11
Case: 12



BASKET CENTERPIECE 20"

#749-70
Diameter: 20"
Height: 8"
Soil capacity (L): 20
Case: 12

Hooks and chains sold separately to better suit your needs. See page 17.

Our baskets come with a metal frame and are fitted with a plastic bag.

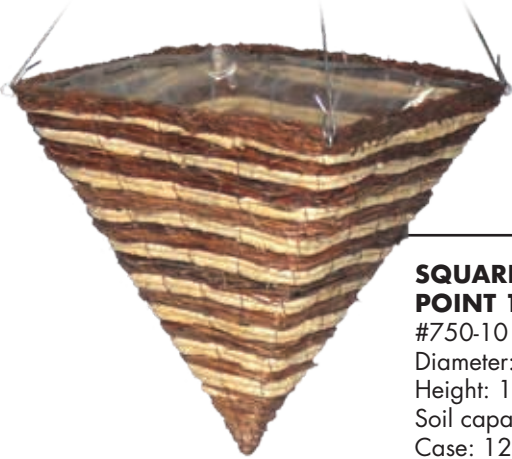

SQUARE POINT 14"

#750-10
Diameter: 14"X14"
Height: 15"
Soil capacity (L): 13
Case: 12



SQUARE 14"

750-11
Diameter: 14"X14"
Height: 8"
Soil capacity (L): 11
Case: 12



CONE 14"

#750-12
Diameter: 14"
Height: 15"
Soil capacity (L): 13
Case: 12

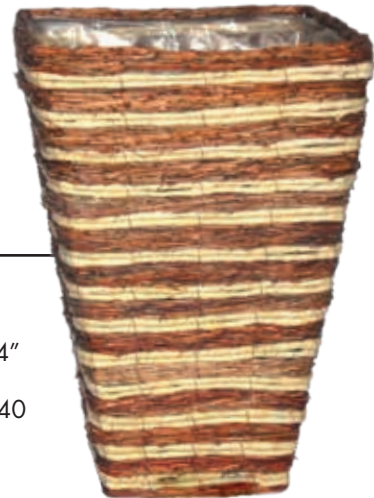

URN 14"

750-13
Diameter: 14"X14"
Height: 20"
Soil capacity (L): 40
Case: 8

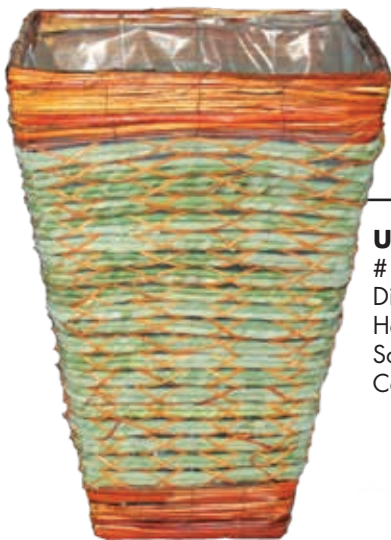

URN 14"

750-40
Diameter: 14"X14"
Height: 20"
Soil capacity (L): 40
Case: 8

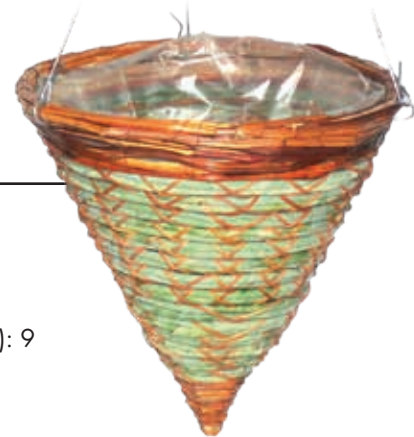

CONE 14"

#750-36
Diameter: 14"
Height: 15"
Soil capacity (L): 9
Case: 12



CONE 14"

#750-50
Diameter: 14"
Height: 15"
Soil capacity (L): 9
Case: 12

AVAILABLE PRODUCTS



CONE 14"

#750-18
Diameter: 14"
Height: 15"
Soil capacity (L): 9
Case: 12

CONE 16"

#750-19
Diameter: 16"
Height: 17"
Soil capacity (L): 14
Case: 12



CONICAL EXTRA 14"

750-16
Diameter: 14"
Height: 15"
Soil capacity (L): 9
Case: 8



HALF-CONE 14"

#750-20
Diameter: 14"
Height: 23"
Soil capacity (L): 7
Case: 12



BEEHIVE 14"

750-15
Diameter: 14"
Height: 15"
Soil capacity (L): 13
Case: 12



NATURAL MOSS BASKET 12"

400-J12MOS
Diameter: 12"
Height: 5.75"
Soil capacity (L): 5
Case: 12

NATURAL MOSS BASKET 14"

400-J14MOS
Diameter: 14"
Height: 6.75"
Soil capacity (L): 9
Case: 12

NATURAL MOSS BASKET 16"

400-J16MOS
Diameter: 16"
Height: 7"
Soil capacity (L): 11
Case: 12



FLOWER BOX 30"

#750-17
Diameter: 30"
Height: 8"
Soil capacity (L): 21
Case: 12



CONE 14"
 #750-23
 Diameter: 14"
 Height: 15"
 Soil capacity (L): 13
 Case: 12

CONE 16"
 #750-24
 Diameter: 16"
 Height: 17"
 Soil capacity (L): 14
 Case: 12

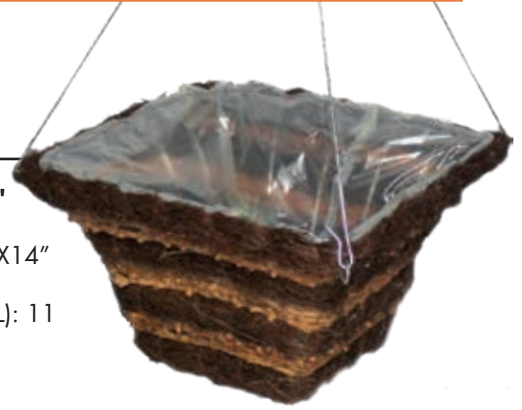

SQUARE 14"
 # 750-26
 Diameter: 14"X14"
 Height: 8"
 Soil capacity (L): 11
 Case: 12



FLAT BASKET 14"
 #750-28
 Diameter: 14"
 Height: 8"
 Soil capacity (L): 9
 Case: 12

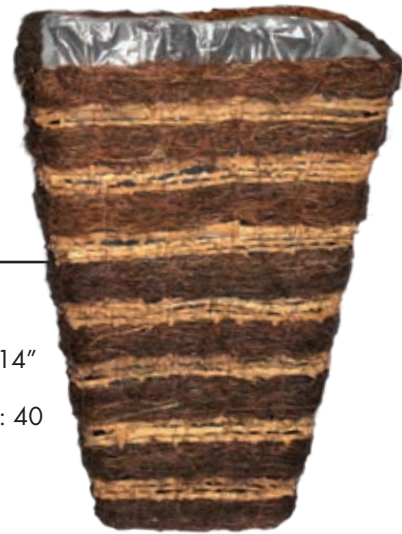

URN 14"
 # 750-27
 Diameter: 14"X14"
 Height: 20"
 Soil capacity (L): 40
 Case: 8



FLOWER BOX 30"
 #750-25
 Diameter: 30"
 Height: 8"
 Soil capacity (L): 21
 Case: 12

Hooks and chains sold separately to better suit your needs. See page 17.

Our baskets come with a metal frame and are fitted with a plastic bag.



ROUND 12"
 # 750-54
 Diameter: 12"
 Height: 8"
 Soil capacity (L): 7
 Case: 12

ROUND 14"
 # 750-55
 Diameter: 14"
 Height: 8"
 Soil capacity (L): 9
 Case: 12

ROUND 16"
 # 750-56
 Diameter: 16"
 Height: 8"
 Soil capacity (L): 11
 Case: 12

AVAILABLE PRODUCTS



ROUND 16"
 # 750-30
 Diameter: 16"
 Height: 8"
 Soil capacity (L): 11
 Case: 12



SQUARE 14"
 # 750-33
 Diameter: 14"X14"
 Height: 8"
 Soil capacity (L): 11
 Case: 12



FLOWER BOX 30"
 #750-32
 Diameter: 30"
 Height: 8"
 Soil capacity (L): 21
 Case: 12



BEEHIVE 14"
 # 750-31
 Diameter: 14"
 Height: 15"
 Soil capacity (L): 13
 Case: 12



CONE 14"
 #750-62
 Diameter: 14"
 Height: 15"
 Soil capacity (L): 13
 Case: 12



FLAT BASKET 14"
 # 750-61
 Diameter: 14"
 Height: 6"
 Soil capacity (L): 8
 Case: 12

Hooks and chains sold separately to better suit your needs. See page 17.

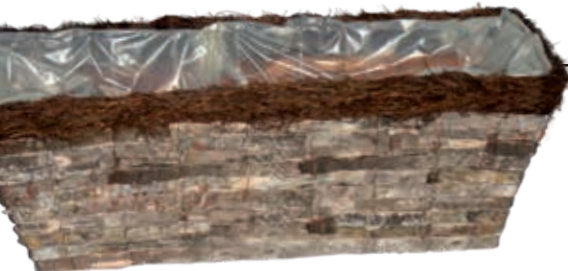

FLOWER BOX 30"
 #750-63
 Diameter: 30"
 Height: 8"
 Soil capacity (L): 21
 Case: 12



HALF-CONE 14"
 #750-60
 Diameter: 14"
 Height: 23"
 Soil capacity (L): 7
 Case: 12



CONE 14"
 #750-70
 Diameter: 14"
 Height: 15"
 Soil capacity (L): 9
 Case: 12



SQUARE POINT 14"
 # 750-71
 Diameter: 14"X14"
 Height: 15"
 Soil capacity (L): 13
 Case: 12



URN 14"
 # 750-77
 Diameter: 14"X14"
 Height: 20"
 Soil capacity (L): 40
 Case: 8



ROUND 14"
 # 750-72
 Diameter: 14"
 Height: 8"
 Soil capacity (L): 9
 Case: 12



CONE 14"
 #750-74
 Diameter: 14"
 Height: 15"
 Soil capacity (L): 9
 Case: 12



ROUND 14"
 # 750-73
 Diameter: 14"
 Height: 8"
 Soil capacity (L): 9
 Case: 12



SQUARE POINT 14"
 # 750-76
 Diameter: 14"X14"
 Height: 15"
 Soil capacity (L): 13
 Case: 12

Our baskets come with a metal frame and are fitted with a plastic bag.

AVAILABLE PRODUCTS



SQUARE POINT 14"
750-78
Diameter: 14"X14"
Height: 15"
Soil capacity (L): 13
Case: 12



FLAT BASKET 14"
750-75
Diameter: 14"
Height: 9"
Soil capacity (L): 9
Case: 12



CONE 14"
#750-79
Diameter: 14"
Height: 15"
Soil capacity (L): 9
Case: 12

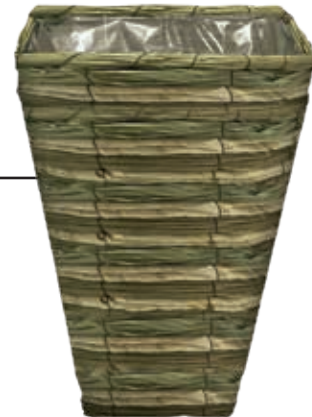

URN 14"
750-80
Diameter: 14"X14"
Height: 20"
Soil capacity (L): 40
Case: 8



CONE 14"
#750-81
Diameter: 14"
Height: 15"
Soil capacity (L): 9
Case: 12



ROUND 14"
750-82
Diameter: 14"
Height: 8"
Soil capacity (L): 9
Case: 12



HALF CONE BASKET 14"
#750-84
Diameter: 14"
Height: 23"
Soil capacity (L): 7
Case: 12

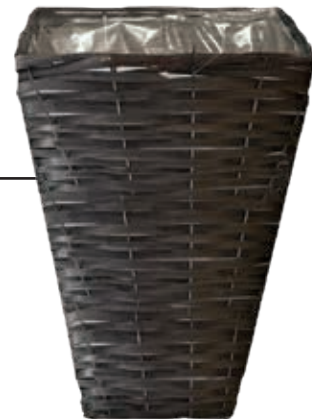

URN 14"
750-83
Diameter: 14"X14"
Height: 20"
Soil capacity (L): 40
Case: 8



BASKET CENTERPIECE 20"
#750-85
Diameter: 20"
Height: 8"
Soil capacity (L): 20
Case: 12

CONICAL SUPPORT
#780-VAL
Case: 30

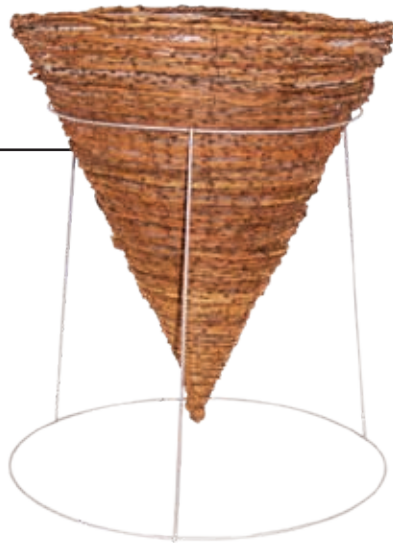

Perfect for production and transportation of conical baskets.

Offer these economical supports to your customers. They prevent damage during transportation and come in handy for interior storage on frosty nights.

SQUARE SUPPORT
#781-VALC
Case: 30

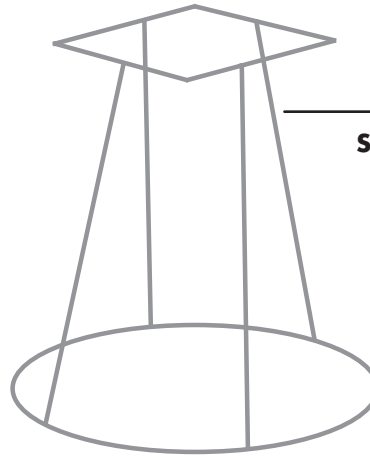

**DECORATIVE SUPPORT
CORKSCREW FINISH**
#750-67
Top ring: 11"
Middle ring: 6"
Total height: 21 1/4"
Case: 12

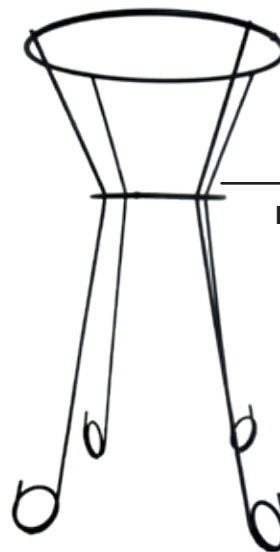

**STURDY SUPPORT
ROUND FINISH**
#750-66
Top ring: 11"
Middle ring: 6"
Total height: 21 1/4"
Case: 12



MAKE YOUR
ENVIRONMENT
BLOOM

UR
NT
M!

URBAN PRODUCTS!

MAKE YOUR ENVIRONMENT BLOOM!
Strengthen civic pride and increase admiration and satisfaction from neighbouring communities.
Floral adornments promote quality and care in urban environments.

OUR FAVORITE!

Concrete vases
 730-PR24
 Height: 12" (304.8 mm)
 Width: 24" (609.6 mm)
 Weight: 70 kg (154 lb)



Products for:
 Downtown areas
 Municipal buildings
 Boulevards
 Bridges
 Cycling paths
 Tourist sites
 Commercial areas



Concrete vases, see page 38 for more details



Concrete vases, see page 38 for more details



Base baskets, see page 38 for more details

ARCHED HANGERS

DECORATIVE ARCHED HANGER

Made of robust steel, black painted. Simple and easy to install with our aluminum fittings (not-included).

Designed for flower baskets from 10" to 16" in diameter.



EXTRA STRONG DECORATIVE HANGER

Robust steel hanger with a decorative brace. Designed for baskets from 18" to 24" in diameter.

Available with a black powder coating finish or galvanized-steel. Install with fitting #424-HV-FX (not-included).



Arched hangers

ALUMINIUM FITTING

For steel post. Two fittings required per hanger.

Attach with two 3/4" X 0,030 mm stainless-steel straps (not included).



424-FX
Use with
Arched hanger
Case: 2



424-HV-FX
Use with
Extra strong hanger
Case: 2



Suggested to attach the fitting:
Size: 3/8" / Length: 1 1/4"
(Not included)

The ideal lamp post adornment.

Our galvanized-steel lamp post basket can handle considerable weight and severe weather conditions.

They come with green plastic bag.
Can also be used with coco liner (see Coco Roll page 10).

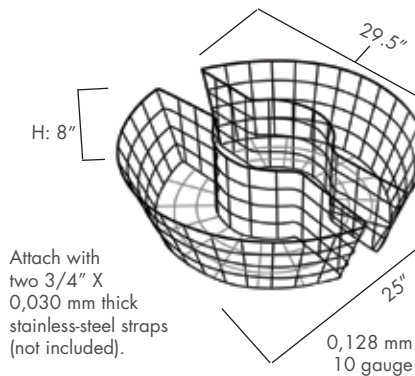

422-LAM

Color: Galvanized
Green bag, included
Soil cap. liters: 26
Case: 2 half-baskets (for 1 post)
Replacement bag: 401-LAM (12/cs)

Order for 1 or more posts



Drain your basket, by piercing the bag bottom every third wire rods.

SUPPORT FOR LAMP POST BASKET

To fasten the lamp post basket shown above. Made of sturdy steel to ensure durability. Can be used year-round. Can easily be installed with two 3/4" stainless steel straps (not-included).

422-SPL

Color: Galvanized
Installation:
For 6" to 10" posts
Case: 2 supports (for 1 post)

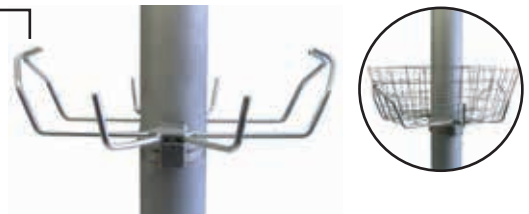

ALUMINIUM FITTING

For small posts (4" to 6")

Two fittings required per post.
Attach with two 3/4" X 0,030 mm thick stainless-steel straps (not included).

424-FITT

Color: Galvanized
Case: 2

Order for 1 or more post

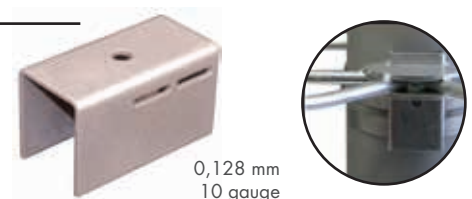

0,128 mm
10 gauge

BASE BASKETS

Useful for decorating the base of trees and lamp posts. Avoid disturbing the soil around the roots and protect your trees from accidental injury.

Sturdy and durable construction. Flowers can be set through the sides of the wire mesh as well as on top.

Clear plastic bag included. Coco liner also available (see Coco Roll page 10).

Also available in square or rectangular shape.

875-SOL

Size base: 36" X 12"
Soil capacity (liters): 90
Case: 1 half-basket
Replacement bag: 876-SAC



Base baskets

One Coco
ROLL can line
up to
4 half-baskets.

CONCRETE VASES

Textured concrete flower containers

Imitation natural stone finish. Resistant to freeze and thaw cycles and abrasives. Great stability. Optional ground anchors and adjustable legs.

Available in 6 sizes and 2 colors: beige or charcoal.



725-P30



725-P36



725-P42



730-P2429



730-P2443



730-PR24

Winter storage:
Leave the soil inside
and make sure that
the water can come
out underneath.

	30" (762 mm)	36" (914 mm)	42" (1067 mm)	24" (737 mm)	24" (737 mm)	24"* (737 mm)
#	725-P30	725-P36	725-P42	730-P2429	730-P2443	730-PR24
WEIGHT	139 kg (305 lb)	155 kg (340 lb)	173 kg (380 lb)	274 kg (604 lb)	347 kg (765 lb)	70 kg (154 lb)
WIDTH	21.5" (546 mm)	21.5" (546 mm)	21.5" (546 mm)	29" (737 mm)	43" (1092 mm)	24" (609.6 mm)

* Also available in 16" and 36"

Add prestige and elegance to a home with flower towers. Use on streets to narrow passageways and slow traffic.

Soil and plants ensure stability. Easy to maintain: water through the central tube to irrigate the full height of the column.

Reusable and sturdily built, a tower can be dismantled in two sections for storage.

Kit for 48" tower includes:

- Metal tower
- Perforated irrigation tube
- Universal base fitting
- Plastic bag
- Barrel not included.
(Except when ordered with 790-COMBO)



Can reach 72" when in full bloom!

SMALL TOWER

407-F24

Height: 24 inches
 Diameter: 10 inches
 Diameter of base: 16 inches
 12 per case
 Green plastic bag included.

Replacement bag:
 401-H (24 per case)

Drain, by piercing the bottom bag between every 3 wire rods.

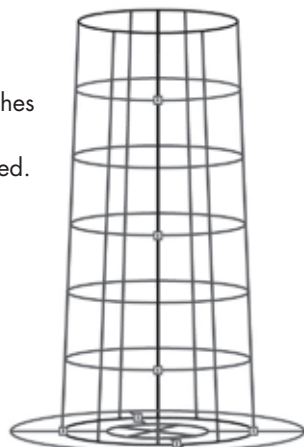

GRAND TOWER

790-STRUC

Height: 48 inches
 Diameter: 12 inches
 Soil cap.: 80 liters
 1 per case
 Transparent plastic bag included
 * Barrel not included.

790-COMBO

Grand tower with 21" barrel included

Replacement bag:
 791-SAC (12 per case)

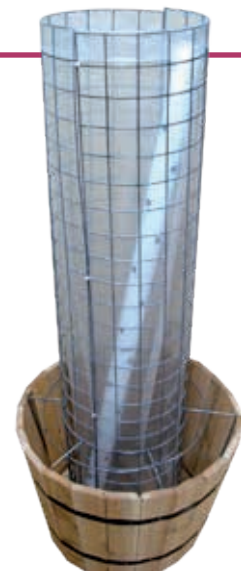

VARIOUS
SUPPORT
AND
TRELLIS FOR
GARDENING

JUST
TSD
D
R
G!

FOR GARDEN-CENTERS

Tool up your garden center
with our pot support system
that adapts to any type of
1 to 5 gallon pots!

OUR POT SUPPORT SYSTEM :

- Prevents pots from falling or blowing over
- Ideal for showcasing plants and shrubs
- Ensures proper watering
- Strong visual impact: neat and orderly
- Quickens inventory count
- Stackable and easy storage
- Lasts from 10 to 15 years

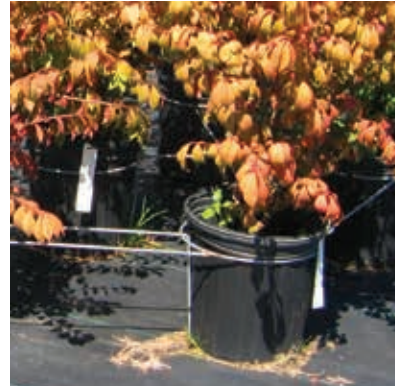

Multi-Pot supports for garden-centers to stabilize plants and shrubs.

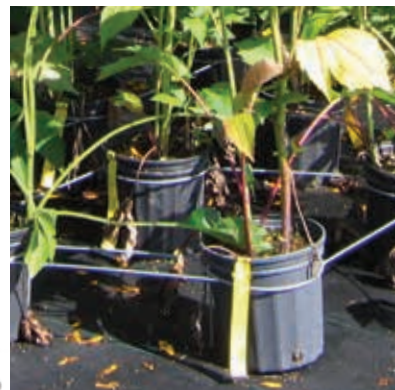

Multi-Pot supports, see page 42 for more details



Balcony-plant cages, see page 43 for more details

MULTI-POT SUPPORTS



	For pots sizes 300 to 400	For pots sizes 600 to 1000	For pots sizes 1200 to 1600	For pots sizes 2000 to 2800
#	550-300MB	551-600MB	552-1200MB	553-2000MB
CAPACITY	2.38L to 2.84L (1g)	6L to 7.30L (1.6g to 1.93g)	9.47L to 14.2L (2.5g to 3.75g)	14.8L to 17.7L (3.90g to 4.67g)
SUPPORT	12 pots	6 pots	6 pots	6 pots
DIMENSIONS	31 1/2" X 43 1/2"	24" X 39"	27 1/2" X 44"	38" X 46 1/2"
CASE	6 (for 72 pots)	6 (for 36 pots)	6 (for 36 pots)	6 (for 36 pots)
DISTANCE BETWEEN POTS	5"	5"	5"	4"
PALLET	25 cs	40 cs	30 cs	20 cs

PALLET-FIX SUPPORTS

Move many trees at a time with Pallet-FIX supports. Makes safely rearranging your displays a snap.

Not only will you save time, but your trees will not blow over - meaning more vigorous growth and a higher retail value.



For 5 gallon pot*
850-5G
12 per case

Fix with metal plates
(not included).



Suggested metal plate

* Also available in 10 gallons.



Create a vegetable garden on a balcony, a terrace or even a rooftop!

Much appreciated by consumers, balcony cages support any climbing vegetable. Sturdy and durable, they can be used as handles to move the plant around.

Save on labour and improve quality! Simply place your pot in the cage and your plants will climb—without ties or stakes.

CAN ALSO BE ORDERED IN GREEN, YELLOW, RED and PINK (LIMITED QUANTITIES).



Insert in pot,
carry and transplant
without removing
from the plant.



	For pot 600 (2 gallons)	For pot 1200 (3 gallons)	For pot 1600 (4 gallons)
#	431-TP6	431-TP12	431-TP16
HEIGHT	32"	32"	32"
BOTTOM RING DIAMETER	9 1/2"	10 1/4"	11 1/2"
CASE	25	25	25
PALLET	36 cs (900 units)	36 cs (900 units)	30 cs (750 units)



TOMATO CAGES

Top quality tomato cages made of galvanized steel. Rust-proof with long-lasting welds.

CAN ALSO BE ORDERED IN GREEN, YELLOW, RED and PINK (LIMITED QUANTITIES).



	32"	42"	48"
#	432-CT3210	432-CT4210	432-CT48
RODS	10 gauge	10 gauge	9 gauge
RINGS	12 gauge	12 gauge	9 gauge
TOP RING DIAMETER	13"	14"	15 1/2"
CASE	25	25	12
PALLET	45 cs (1125 units)	45 cs (1125 units)	18 cs (216 units)

MIXED PALLET

432-MIX
 Cage 32".....15 cs.....375
 Cage 42".....12 cs.....300
 Cage 48"..... 6 cs.....72
 Pallet : 33 cs

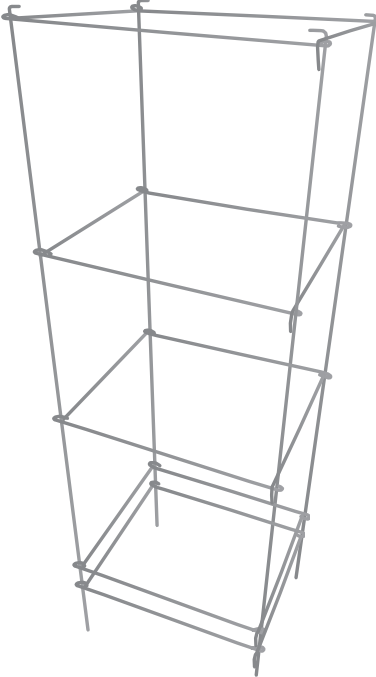

SQUARE TOMATO CAGES

	48"
#	432-CT48R
RODS	9 gauge
WIDTH	16 1/2"
DEPTH	13 1/2"
CASE	6



433-PINCE
 Sharp edge will ease plant trimmings.
 1 per case

FLOWER BOX SUPPORTS

Made of robust steel, painted in black, our flower box supports can be easily married with our production baskets and flower boxes.

«SIMPLE» SUPPORT

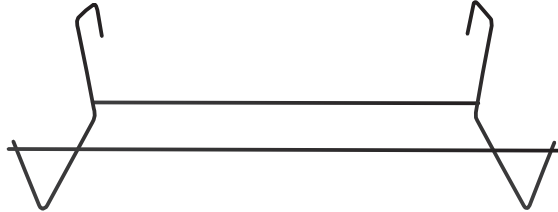

12"	20"	#
450-SB01	450-SB02	
4 1/2"	4 1/2"	REAR HEIGHT
3"	3"	FRONT HEIGHT
8"	8"	DEPTH
Black	Black	COLOR
12 pounds	20 pounds	MAXIMUM CHARGE
6	6	CASE

«STYLISH» SUPPORT

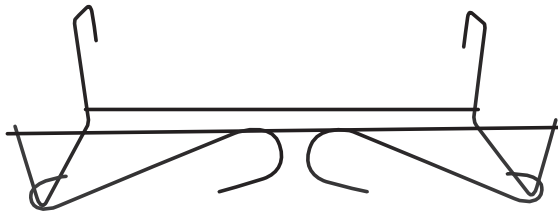

12"	20"	#
450-SB03	450-SB04	
4 1/2"	4 1/2"	REAR HEIGHT
3"	3"	FRONT HEIGHT
8"	8"	DEPTH
Black	Black	COLOR
12 pounds	20 pounds	MAXIMUM CHARGE
6	6	CASE

«V» SUPPORT

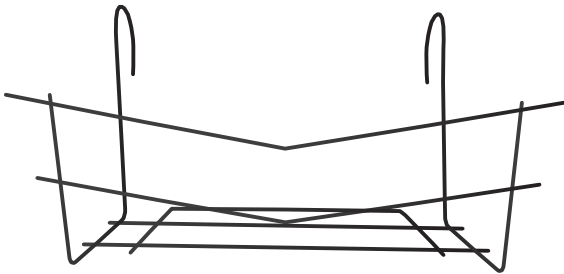

12"	20"	#
450-SB05	450-SB06	
8"	8"	REAR HEIGHT
5"	5"	FRONT HEIGHT
8"	8"	DEPTH
Black	Black	COLOR
12 pounds	20 pounds	MAXIMUM CHARGE
6	6	CASE

«SMILING» SUPPORT

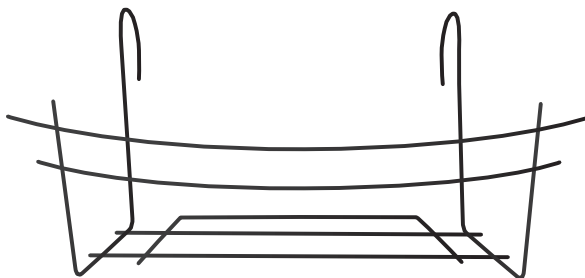

12"	20"	#
450-SB07	450-SB08	
8"	8"	REAR HEIGHT
5"	5"	FRONT HEIGHT
8"	8"	DEPTH
Black	Black	COLOR
12 pounds	20 pounds	MAXIMUM CHARGE
6	6	CASE

«HOOK» SUPPORT

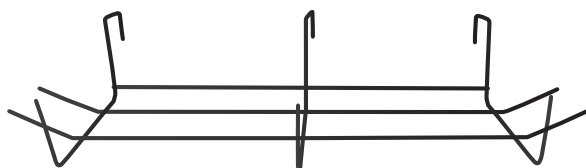

12"	20"	#
450-SB09	450-SB10	
4 1/2"	4 1/2"	REAR HEIGHT
3 1/2"	3 1/2"	FRONT HEIGHT
8"	8"	DEPTH
Black	Black	COLOR
12 pounds	20 pounds	MAXIMUM CHARGE
6	6	CASE

DAHLIA SUPPORTS

Save time and improve quality.

Robust and reusable, these supports are used for production and for retailing.

32"		42"		
495-DAHL32		495-DAHL42		#
8 1/2"		8 1/2"		FIRST RING
7 1/2"		7 1/2"		SECOND RING
6 3/4"		6 3/4"		THIRD RING
25		25		CASE
50 cs		50 cs		PALLET

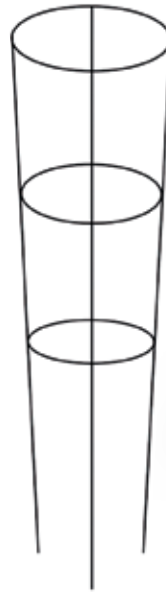

PEONY SUPPORTS

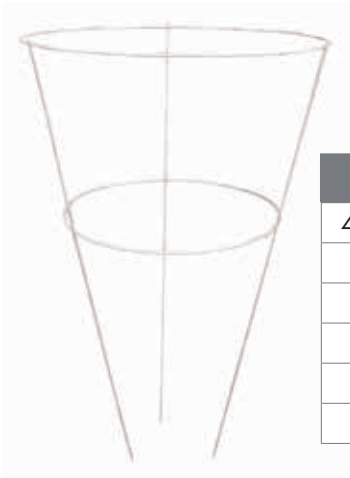

30"		
430-PR30		#
18"		FIRST RING
13 3/4"		SECOND RING
10		GAUGE
25		CASE
500		PALLET

33"		
420-TR33		#
17"		DIAMETER
13		CASE



28"		36"		
420-P128		420-P136		#
17"		17"		DIAMETER
12		12		CASE

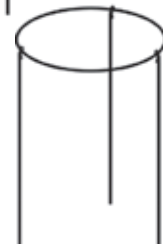

HOP AND HEMP PLANT SUPPORT

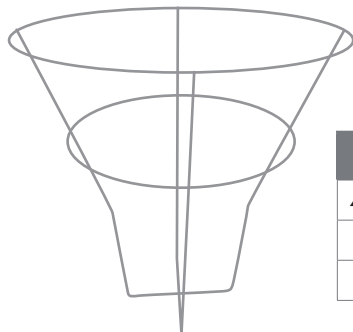

27"		
431-MAR27R		#
24"		TOP RING
25		CASE

ROUND GRID

24"		
431-GRI24R		#
Galvanized steel		COLOR
1		CASE



A profitable investment!

IDENTIFICATION SUPPORTS

CARD STANDS

Product information must be readily available to your customers.

Card stands provide basic information promptly to your customers thus freeing up valuable time for your employees to provide advice and closing sales.



18"	30"	
411-CO18	411-CO30	#
23"	39"	HEIGHT WITH CARD
7 1/4"	10 1/4"	BASE RING
7" X 5"	8" X 9"	COROPLAST CARD INCLUDED
413-CORO / cs50	413-COROG / cs 50	EXTRA COROPLAST
50	50	CASE

PAPER CLIP STYLE CARD STANDS

Similar to a paper clip, simply insert your own cards into this stand.

Designed for cards of all sizes and thicknesses.



18"	30"	
414-AF18	414-AF30	#
7 1/4"	10 1/4"	BASE RING
50	50	CASE

CARD STANDS FOR POTTED PLANTS

Card stand designed for potted plants.

This stand can also be staked in the ground in front of outdoor displays.



28"	
413-PO28	#
30 3/4"	HEIGHT WITH CARD
7" X 5"	COROPLAST CARD INCLUDED
413-CORO / cs50	EXTRA COROPLAST
50	CASE

SILENT SELLERS

PALLET CARD STAND

Simply insert the base of the stand into the pallet. To remove, squeeze the bottom and the stand will slide out easily.

Sturdy enough to remain in place even in high winds.

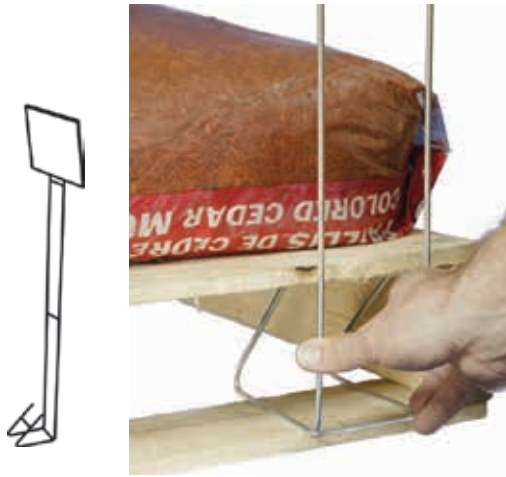

40"		#
410-PA40		HEIGHT WITH COROPLAST
40"		COROPLAST SIZE INCLUDED
413-COROG		EXTRA COROPLAST
25		CASE

HANGING BASKET CARD HOLDER

This holder is designed to display information about the hanging baskets. Hang from either baskets or structural tubing.



18"		#
412-JCO		HEIGHT WITH COROPLAST
18"		COROPLAST SIZE INCLUDED
413-CORO		EXTRA COROPLAST
50		CASE

EXTRA COROPLAST CARDS



7" X 5"	8" X 9"	#
413-CORO	413-COROG	
50	50	CASE

MINI-SUPPORT

No need to tie stems to a stake with our mini-supports!

For production or retail.

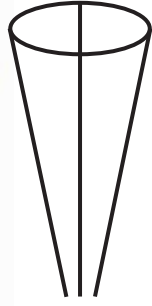

1 GALLON POT

15"	
415-MS7	#
7"	TOP RING DIAMETER
50	CASE

19"	
416-MD12	#
12"	RING DIAMETER
50	CASE

HANGING SUPPORT FOR 4 POTS

Quadruple your potted plant production with our one gallon pot support.

With this support, you can produce large quantities and many varieties of perennials while making the most of the free space in your greenhouse. An automatic watering system can easily be used.

This product is designed to hold the pots level. It requires a four-strand hook (sold separately). You can also add an extension hook for production at different levels. (See page 17).



HOOK SOLD SEPARATELY #400-HK18-4

6.25"	
470-1GAL	#
6"	DISTANCE BETWEEN POTS
24	CASE



IVY SUPPORT

Add ivy to your potted plants. Insert in 6" pot, the support is held in place by two stakes.

15"	
417-SL15	#
25	CASE

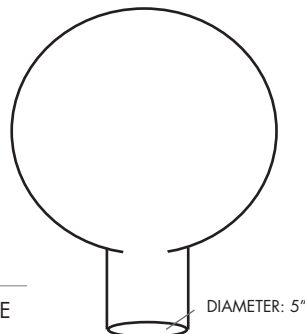

DIAMETER: 5"



PRODUCTION TRELLIS

THE CLASSIC

Climbing plants cling to this trellis and grow evenly. Its bent legs make it stable in a pot.



	24"
#	441-TR24
TOP WIDTH	8"
BOTTOM WIDTH	4"
COLOR	Galvanized
CASE	25

THE ECONOMIC

Practical and cost effective trellis. Its embossed legs give plants a better grip.



	22"
#	444-TC22
COLOR	Galvanized
CASE	100

THE UNIVERSAL

Available in several sizes, this trellis will endow your climbers with style and allure.



	18"	25"	30"
#	441-TR18	441-TR25	441-TR30
WIDTH	3"	5"	5"
COLOR	Galvanized	Galvanized	Galvanized
CASE	25	25	25

THE HANDY

Because of its sturdy base, this trellis is better than a bamboo trellis. Its embossed shape allows plants to cling easily. The top serves as a convenient handle.



	26"
#	445-TR26
DIAMETER	6 1/4"
COLOR	Galvanized
CASE	25

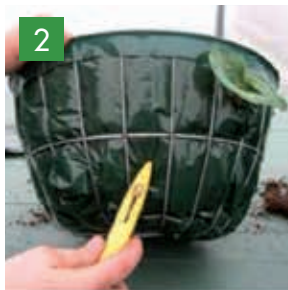
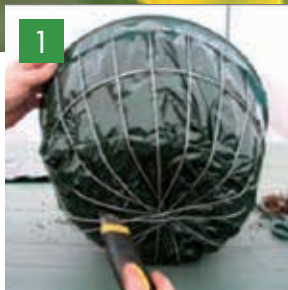

FLORAL ARRANGEMENTS MADE QUICK AND EASY

- 1** Make incisions at every third wire in the bottom of the basket to ensure drainage.
- 2** Make incisions around the sides of the basket at every second or third square, depending on the production lead time you have available. (Tighter planting yields an ample basket more quickly)
- 3** Put your cuttings in the sides, the cut end up and the root down to reduce water loss. Finish the top by planting 1.5" from the edge. Alternate your plants with the plants on the sides to fill empty spaces.
- 4** Attach the hook and water generously. Check soil compaction before hanging.

STABILITY
YOU
POTS WITH
POT-FUSION
SUPPORT

ZE
R
H
N
TS

FOR NURSERIES

**Increase your production
with less staff!**

USING POT-FUSION SUPPORTS

- No more fertilizer waste
- Less time re-arranging pots
- Regular watering increases growth and quality
- Reduces personnel required
- Save time & money working on more profitable tasks
- 2 to 3 years return on investment!



Use Pot-Fusion supports to help stabilize your plants and shrubs in your nursery.



Pot-Fusion supports, see page 54 for more details

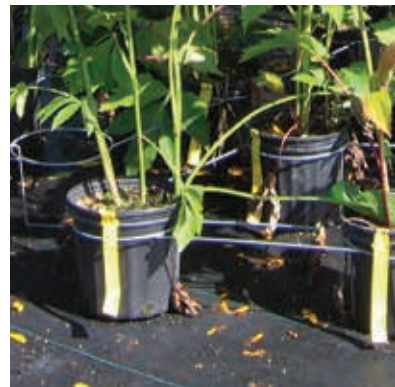

Pot-Fusion supports, see page 54 for more details

POT-FUSION SUPPORTS

Find bio-discs for nurseries on page 9.



Pot-fusion supports

Pot-fusion supports and BioDiscs

MODEL #523-1G6 / #522-300 / #523-400 / #523-400-A

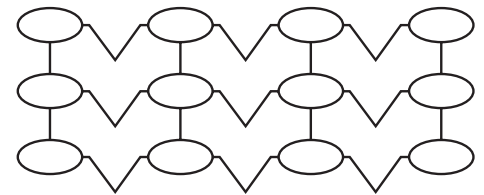
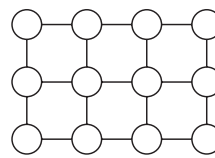
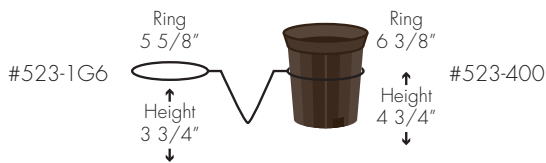

	3L (6,5" x 6,38") 1 gallon	3L	4L (7,75" x 7") 19 cm	4L (7,75" x 7") 19 cm
#	523-1G6	522-300	523-400	523-400-A
DISTANCE BETWEEN POTS	5"	5"	5"	5"
FOR PERENNIALS FROM	12" à 48"	12" à 48"	12" à 48"	12" à 48"
LENGTH AND WIDTH	42" x 30"	41" x 29,5"	44" x 32"	29" x 53"
QTY/CS	12 sup.	12 sup.	12 sup.	12 sup.
QTY/PALLET	20 cases (2 880 pots)	20 cases (2 880 pots)	20 cases (2 880 pots)	20 cases (2 880 pots)

MODEL #524-2G8 / #524-2G12

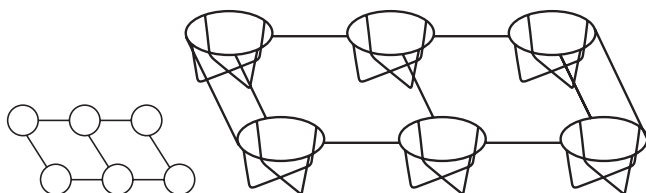
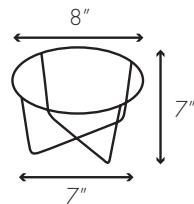

	6L (8,5" x 8,5") 2 gal. / 23 cm	6L (8,5" x 8,5") 2 gal. / 23 cm
#	524-2G8	524-2G12
DISTANCE BETWEEN POTS	8"	12"
FOR SHRUBS FROM	24" à 54"	24" à 54"
6 RINGS OF	8" diam.	8" diam.
LENGTH AND WIDTH	49" x 22"	61" x 27"
QTY/CS	12 sup.	12 sup.
QTY/PALLET	30 cases (2 160 pots)	15 cases (1 080 pots)

MODEL
#525-10008
#525-100012

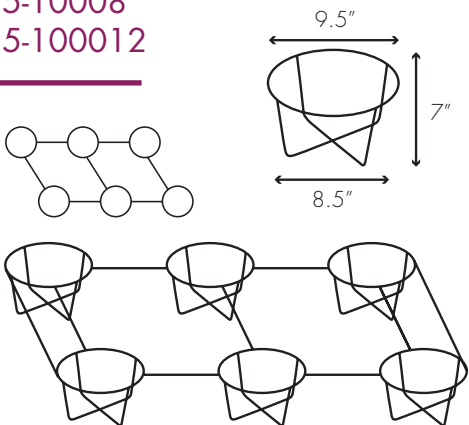

	10L (10"x9") 2.5 gal.	6L (10"x9") 2.5 gal.
#	525-10008	525-100012
DISTANCE BETWEEN POTS	8"	12"
FOR SHRUBS FROM	24" à 66"	24" à 66"
6 RINGS OF	9.5" diam.	9.5" diam.
LENGTH AND WIDTH	54" x 25"	64" x 28.5"
QTY/CS	12 sup.	12 sup.
QTY/PALLET	12 cases (864 pots)	12 cases (864 pots)

MODEL
#527-10DM12

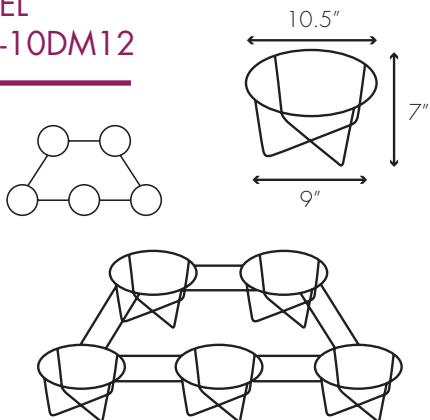

	12" 12L / 3 gallons	15" 12L / 3 gallons
#	527-10DM12	527-10DM15
DISTANCE BETWEEN POTS	12"	15"
FOR SHRUBS FROM	24" à 72"	24" à 72"
5 RINGS OF	10.5" diam.	10.5" diam.
LENGTH AND WIDTH	54" x 30"	61" x 33"
QTY/CS	12 sup.	12 sup.
QTY/PALLET	15 cases (900 pots)	15 cases (900 pots)

MODEL
#528-11DM16

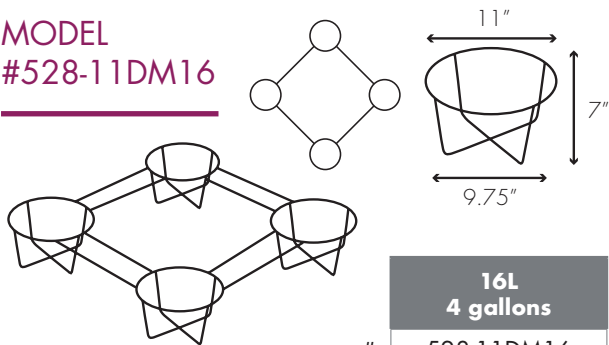

	16L 4 gallons
#	528-11DM16
DISTANCE BETWEEN POTS	16"
FOR SHRUBS FROM	24" à 78"
4 RINGS OF	11" diam.
LENGTH AND WIDTH	50" x 34"
QTY/CS	6 sup.
QTY/PALLET	24 cases (576 pots)

MODEL
#529-13DM17

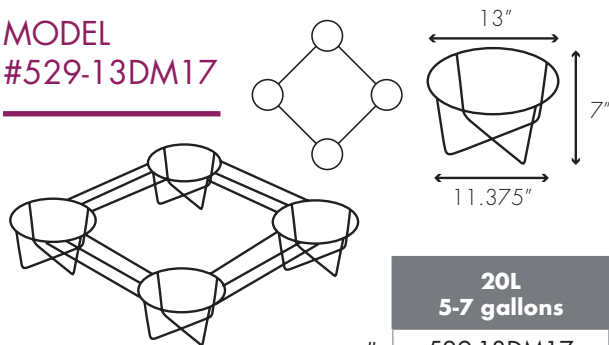

	20L 5-7 gallons
#	529-13DM17
DISTANCE BETWEEN POTS	17"
FOR SHRUBS FROM	24" à 84"
4 RINGS OF	13" diam.
LENGTH AND WIDTH	50" x 40"
QTY/CS	6 sup.
QTY/PALLET	30 cases (720 pots)

CUSTOM
PRODUCT
TO FIT YOUR
NEED

M
T
R
S!

OUR CUSTOM PRODUCTS

Making sure you get the exact product you need is the core purpose of our business.

To compete, your business must optimize its production and retailing methods. Multi-Formes is the right partner for you!

We can design and manufacture the products that will fit your needs and specifications. Our team is capable of making the most complex metal-wire products. Let us know what you need - a rough drawing will do - and after only a few days, you will have a prototype in your hands.



Multi-Formes can manufacture and customize products according to your specific needs.



Follow us on social media

Multi-Formes has made sustained efforts to increase its presence on social media, where you can now follow our most recent news and exclusives. You can now follow the news of **Multi-Formes** and Coco Terro on Facebook, but also on the official Coco Terro Instagram account.

Coco Terro points of sale

Online

Interesting novelty: on the Coco Terro website, we now have an interactive map of the points of sale of our products. We therefore display all the garden centers or shops that distribute our products such as mulch and coco peat, but also our new products such as potting soil and Coco grow stakes. This map provides visibility to our partner companies and allows us to provide greater accessibility to our products. You can contact us if you want to distribute our products or be part of this list in the future!

Visit **cocoterro.com** for details.

Looking at the future

With the past year marked by a pandemic and a global crisis, many businesses that had yet to go digital have decided to make the switch. At **Multi-Formes**, thanks to these new platforms, we are looking to the future to be more easily accessible and to be able to promote our **Multi-Formes** products as well as our various Coco Terro collections.

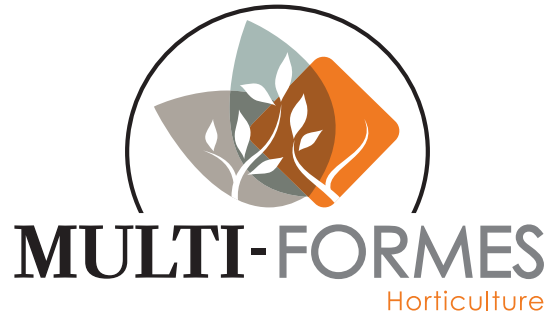

Superior quality horticulture products

CANADA • USA • EUROPE

CONTACT INFORMATION

358, 22^e Avenue
La Guadeloupe (Quebec)
Canada G0M 1G0

info@multi-formes.com

PHONE:

888 680-5430
418 459-3000
Fax:
800 550-5420
418 459-3003

See more of our products
on our website:
www.multi-formes.com

Business hours
Monday to Friday from 8 am to 5 pm

TERMS AND CONDITIONS

Price

Our prices are "Ex Works" or FOB our Warehouse and may be modified at any time without notice.

Payment terms

Our regular payment terms are Net 30 days from date of shipment. In order to obtain credit terms, a customer must fill the appropriate form. After review, Multi-Formes will establish if any, the amount of credit a customer may use. A 2% monthly administrative fee, calculated daily will apply to any past due account. The first order must be paid in full before shipment.

Means of payment

All accounts may be settled by cash, cheque, electronic money transfer or through credit cards. Only VISA and MASTERCARD credit cards are accepted.

Delivery

Multi-Formes will ship all orders in the most efficient and economic way possible at the time of shipment. All orders will be shipped without back orders as much as possible.

Order cancellation

When confirmed, an order cannot be cancelled without the express authorization of Multi-Formes.

Returns and claims

All claims must be made within 10 days of receipt of the goods. After that date, all goods are presumed to have been received in good conditions and with the right quantities. No returns will be accepted without the written approbation of Multi-Formes. A minimum fee of 15% of sales price of the goods returned will be charged to the customer as a special handling charge. Freight cost for returned goods are to be absorbed by the customer and the returned goods must be in their original packaging and must not have been used or otherwise damaged. No return will be accepted past 30 days from date of shipment.

At your
service since
1976

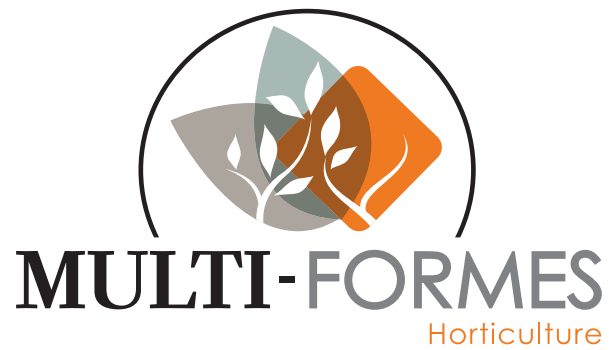

CANADA • USA • EUROPE



PHONE:
888 680-5430
418 459-3000

FAX:
800 550-5420
418 459-3003

MULTI-FORMES.COM
info@multi-formes.com